

Fingerskaret træ vinduer

115, 144, 90 mm. karm, 2 lags glas

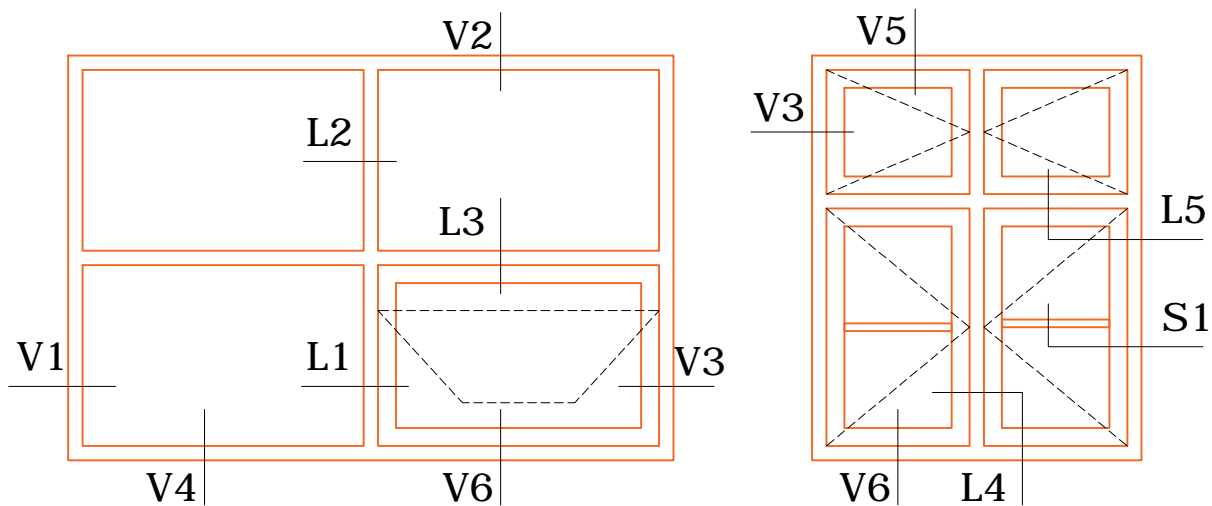

V2: Topkarm faste partier

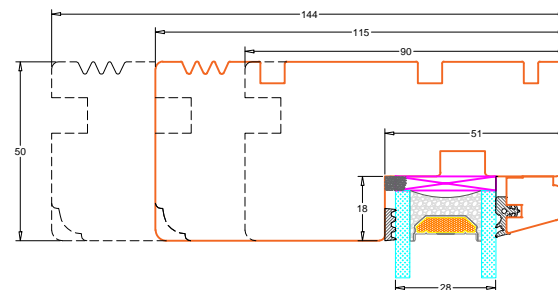

V4: Bundkarm faste partier

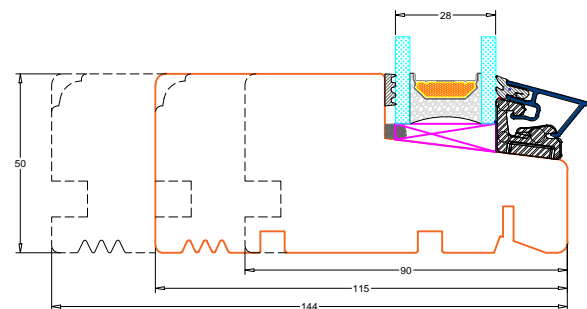

V1: Sidekarme faste partier

L1: Lodpost, fast/åbenbar lodret

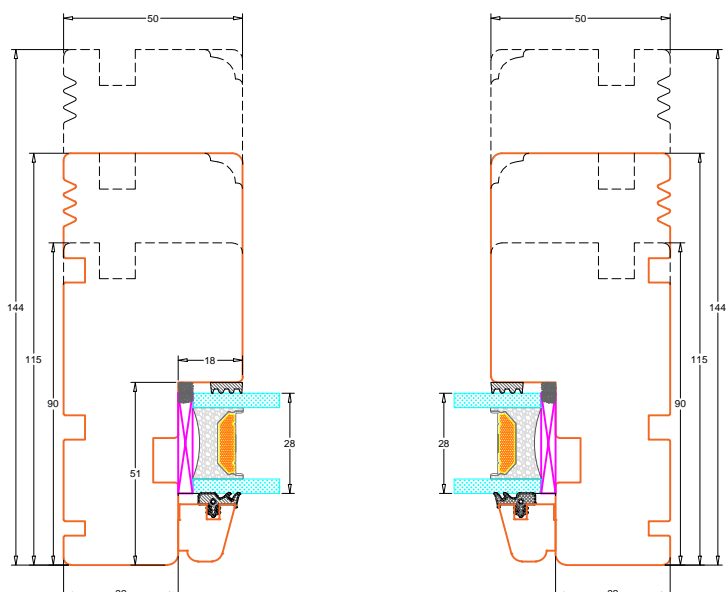

V5: Topkarm åbenbare eller faste partier med ramme

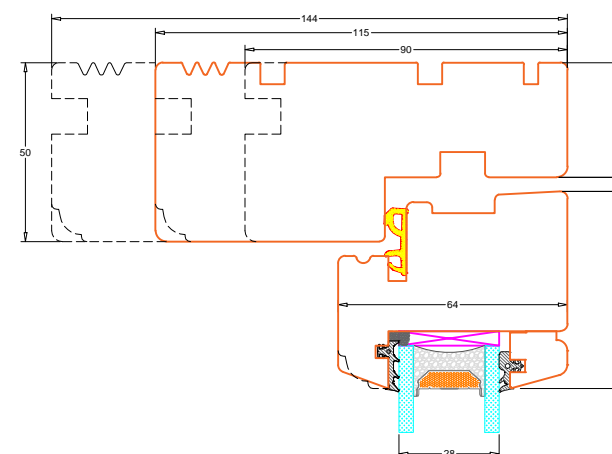

V3: Sidekarme åbenbare eller faste partier med ramme

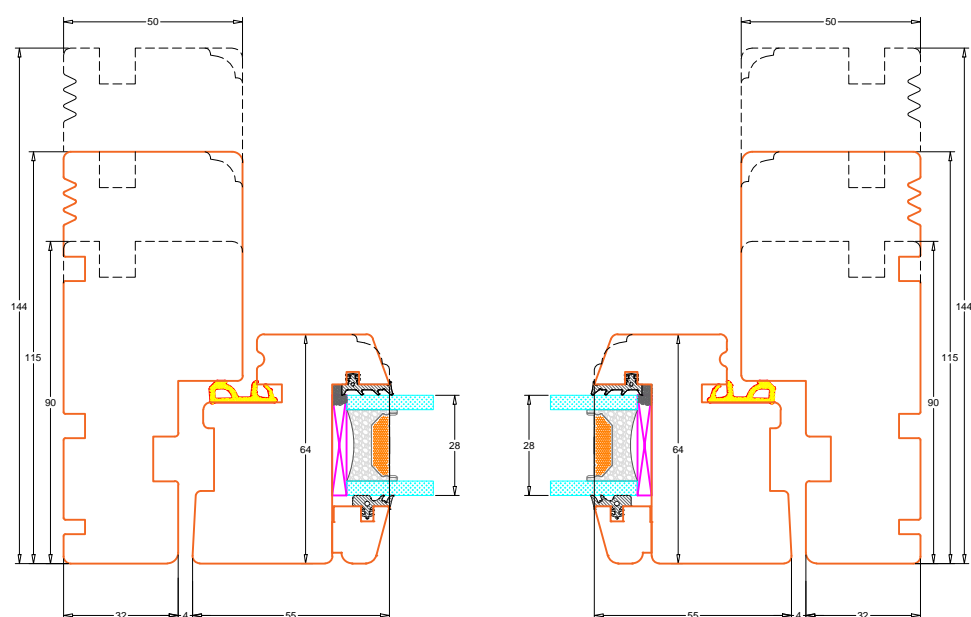

V6: Topkarm åbenbare eller faste partier med ramme

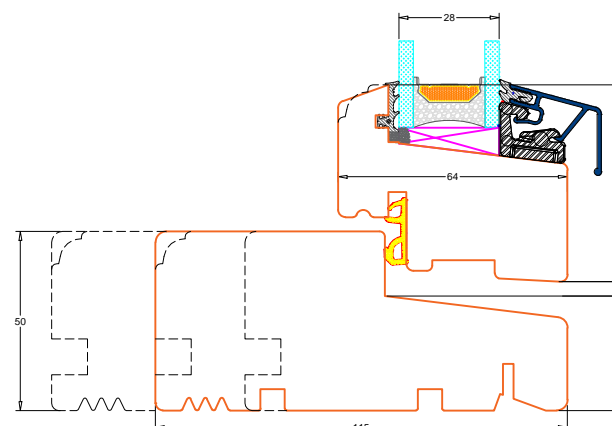

Fingerskaret træ vinduer

115, 144, 90 mm. karm, 2 lags glas

S1: Sprosemuligheder

24 mm. energisprosse
Modern

Indvendig Udvendig

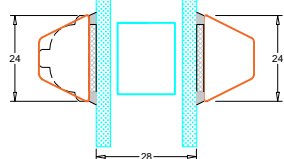

42 mm. energisprosse
Modern

Indvendig Udvendig

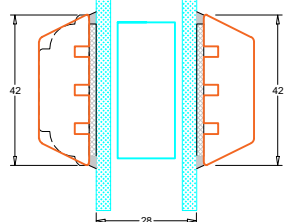

64 mm. gennemgående sprosse
Modern

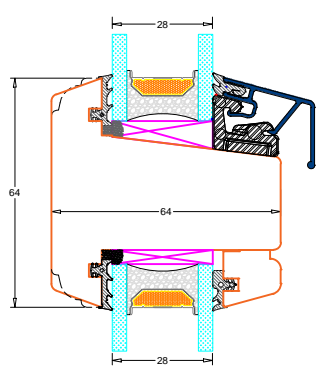

L3: Lodpost, fast/åbenbar vandret 1.

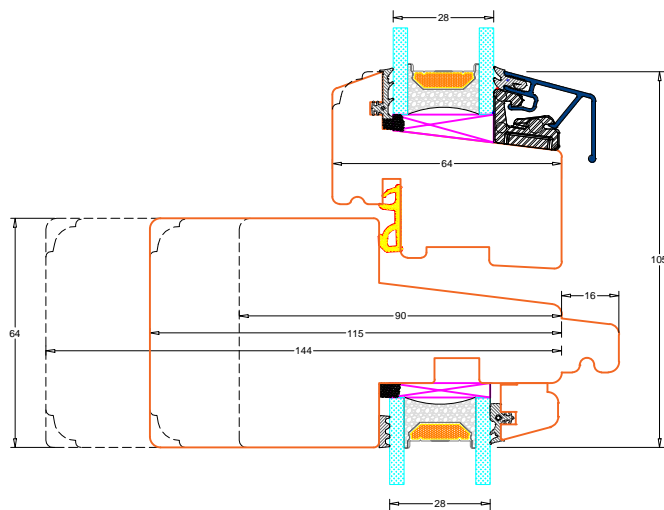

L3: Lodpost, fast/åbenbar vandret 2.

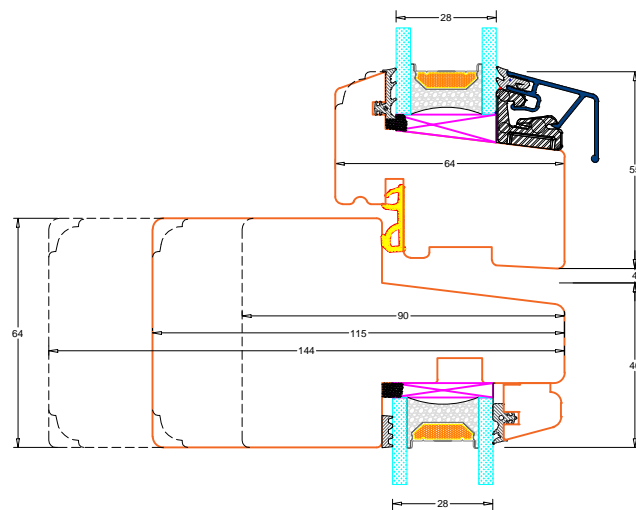

L5: Lodpost, fast/åbenbar vandret 1.

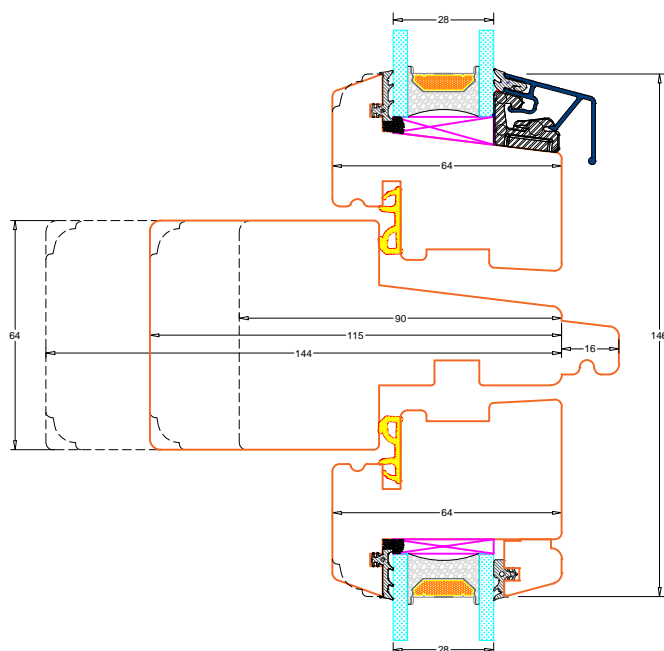

L5: Lodpost, fast/åbenbar vandret 2.

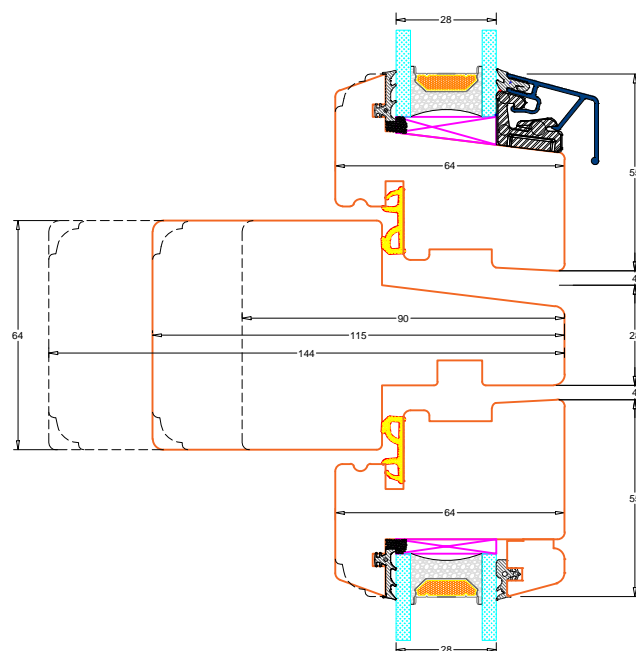

L4: Lodpost, fast/åbenbar lodret

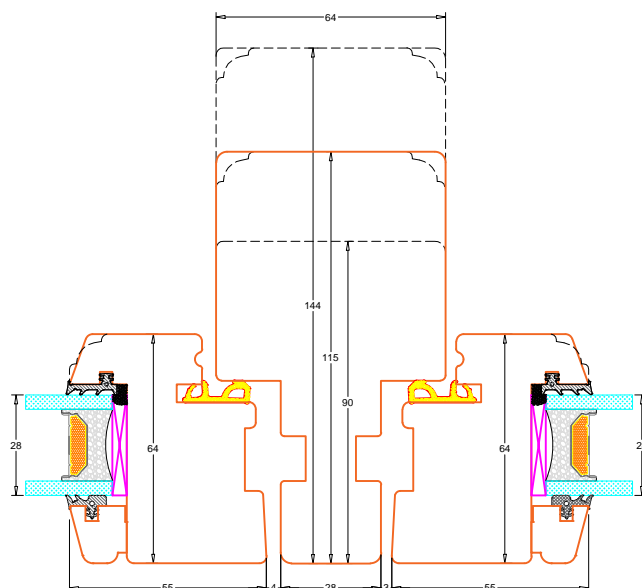

L2: Lodpost, fast/fast lodret

