

Fingerskaret træ/Alu vinduer

128, 157, 103 mm. karm, 2 lags glas

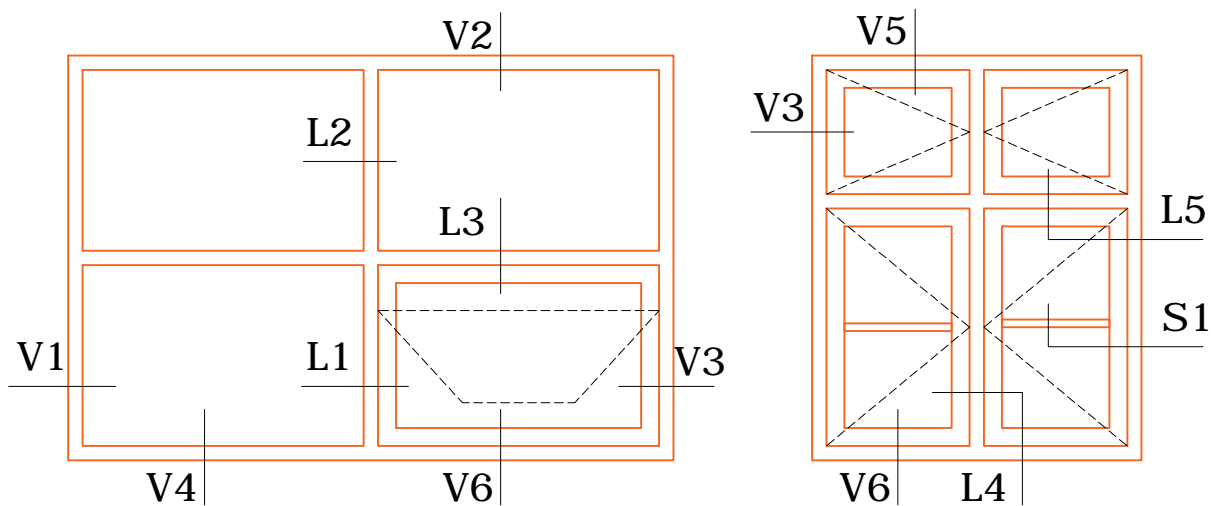

V1: Sidekarme faste partier

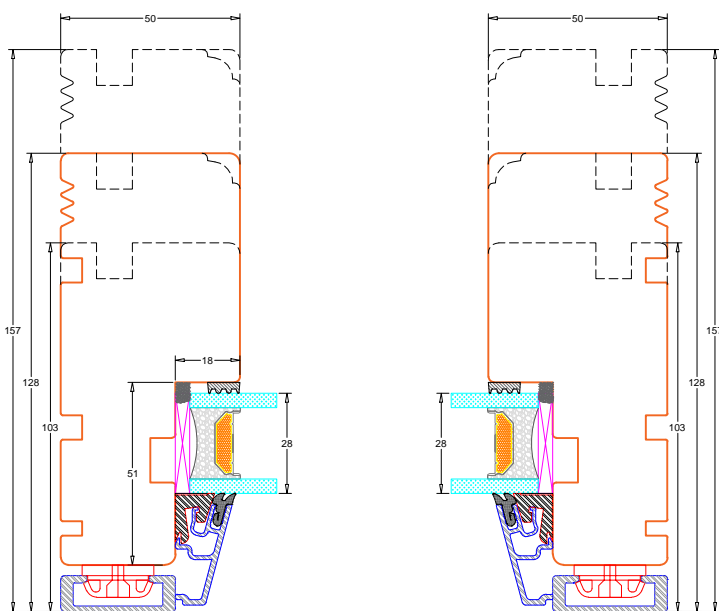

V3: Sidekarme åbenbare eller faste partier med ramme

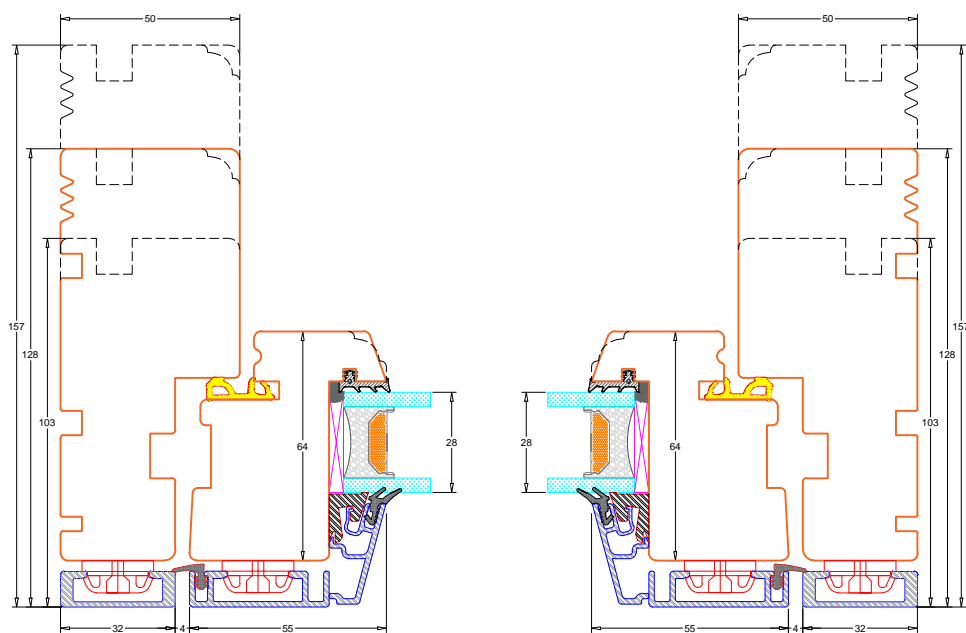

V2: Topkarm faste partier

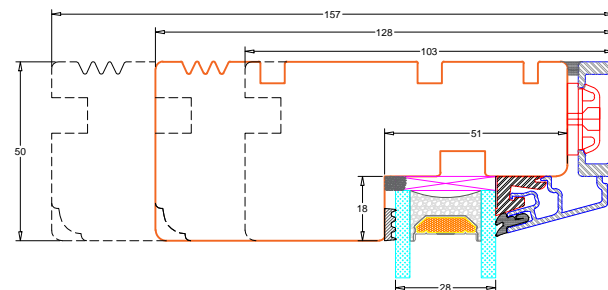

V4: Bundkarm faste partier

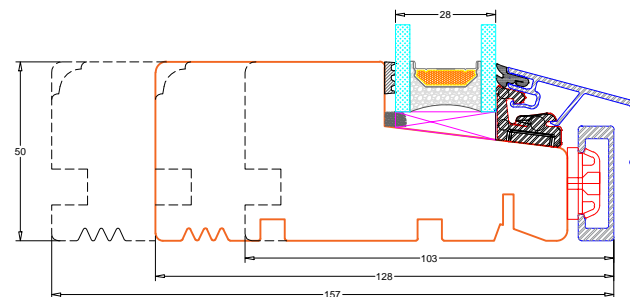

V5: Topkarm åbenbare eller faste partier med ramme

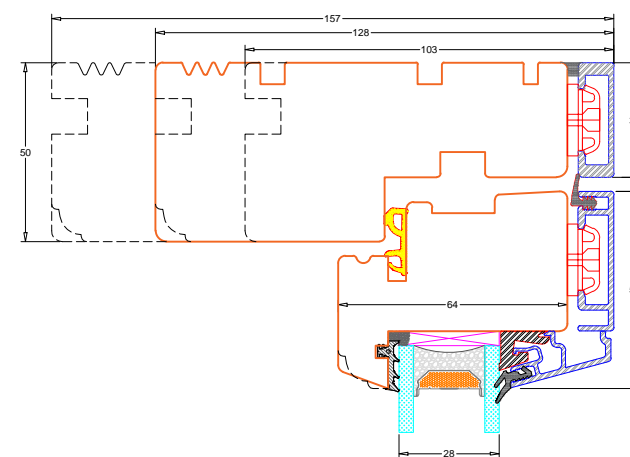

V6: Topkarm åbenbare eller faste partier med ramme

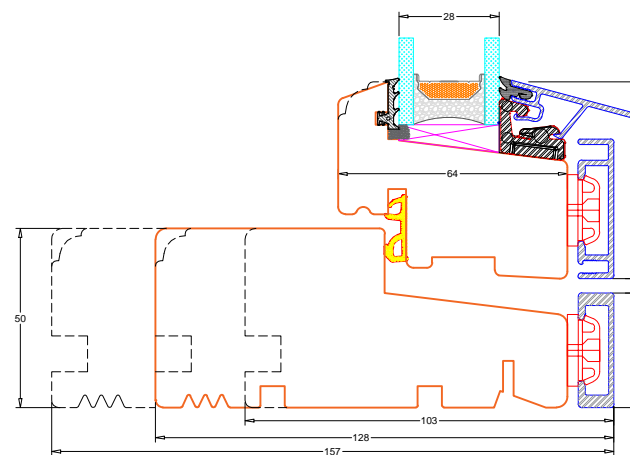

Fingerskaret træ/Alu vinduer

128, 157, 103 mm. karm, 2 lags glas

S1: Sprosemuligheder

24 mm. energisprosse
Modern

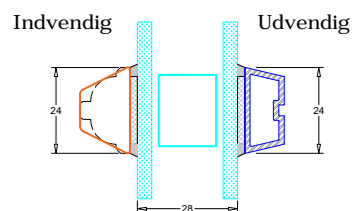

42 mm. energisprosse
Modern

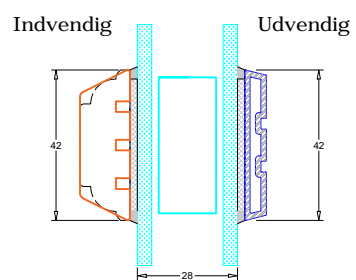

64 mm. gennemgående sprosse
Modern

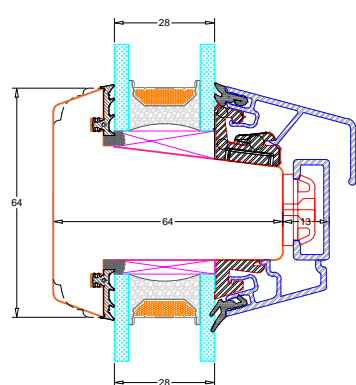

L3: Lodpost, fast/åbenbar vandret

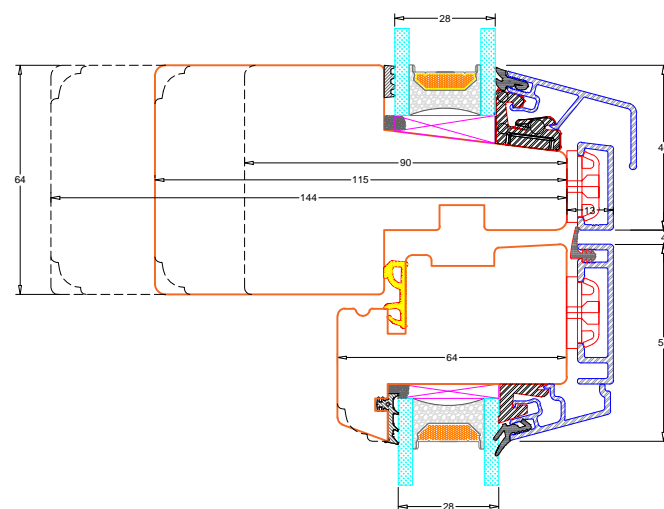

L2: Lodpost, fast/fast lodret

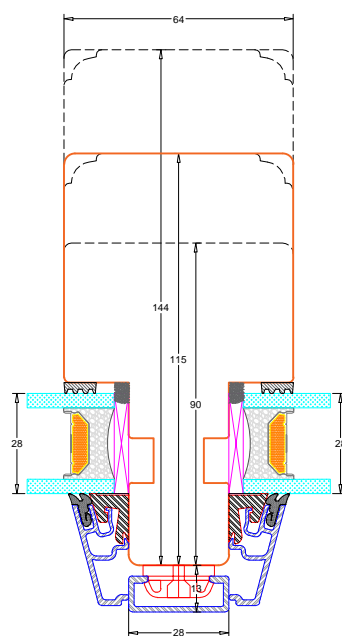

L5: Lodpost, fast/åbenbar vandret

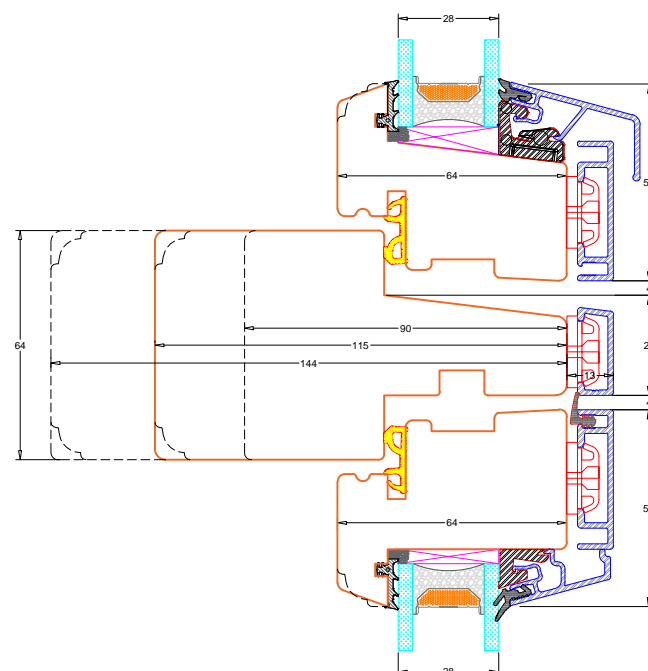

L4: Lodpost, fast/åbenbar lodret

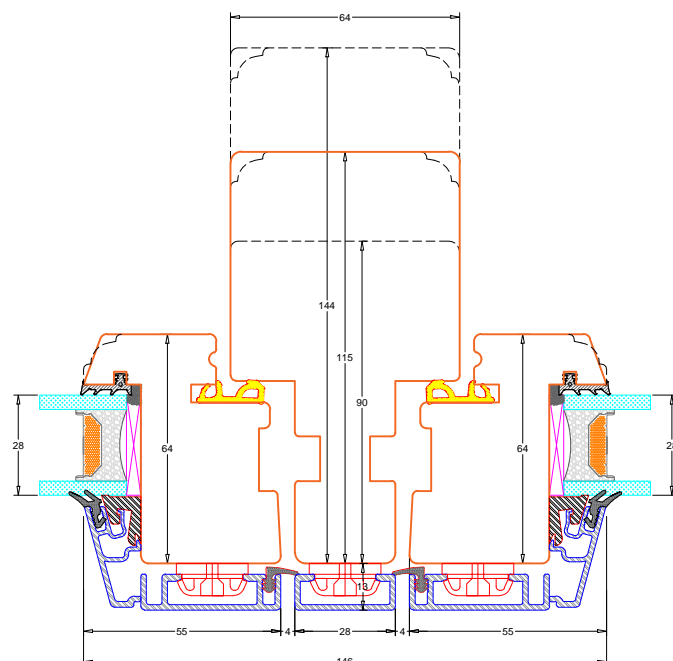

L1: Lodpost, fast/åbenbar lodret

